

PI A.1

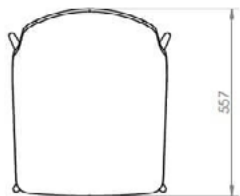

PI A.2

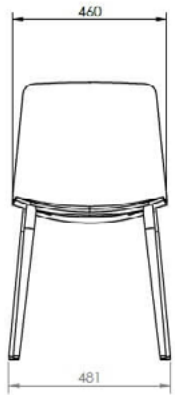
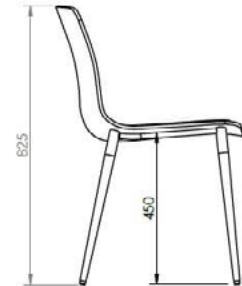

PI A.3

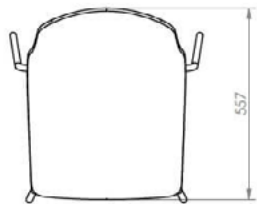
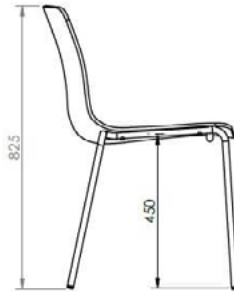
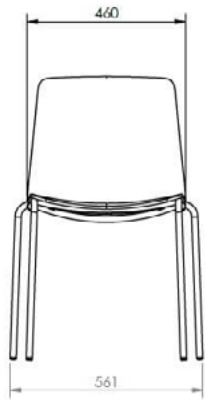

PI A.4

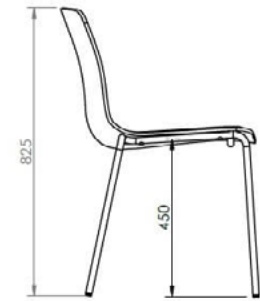

PI A.5

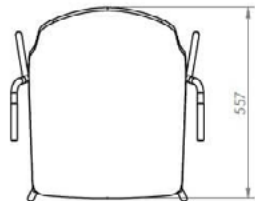
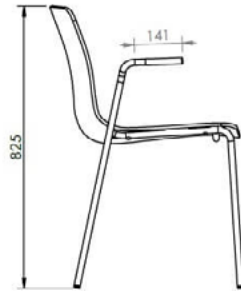
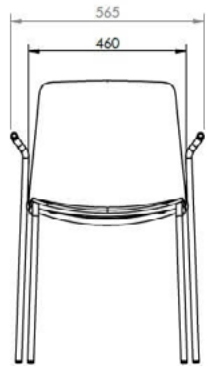

PI A.6

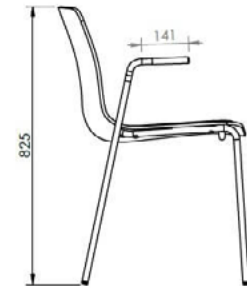
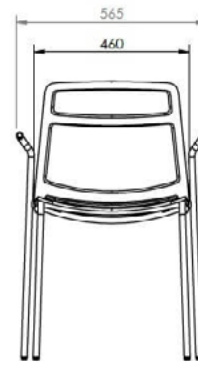

PI A.9



PI A.12



PI B.3



PI B.6

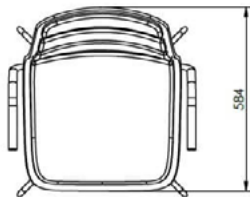
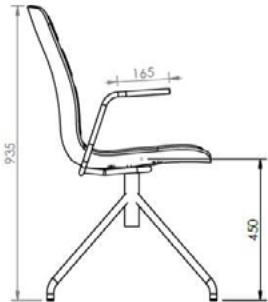

PI C.3



PI C.3

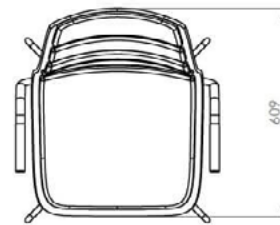
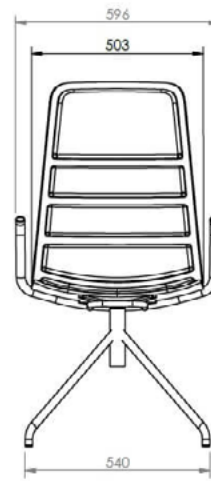

PI E.1

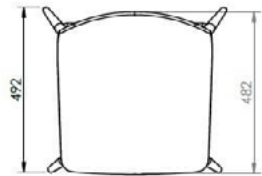
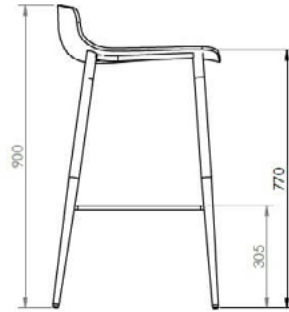
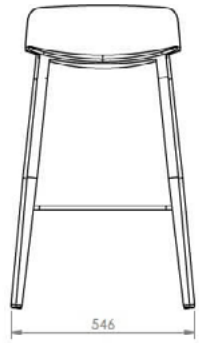

PI E.2

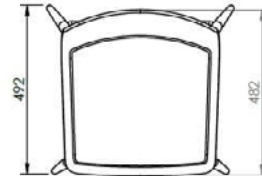
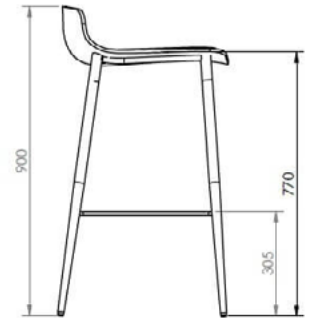

PI F.1

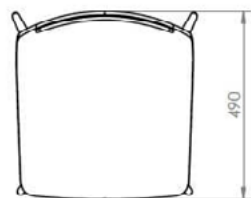

PI F.2

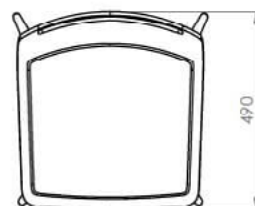

PI G.1

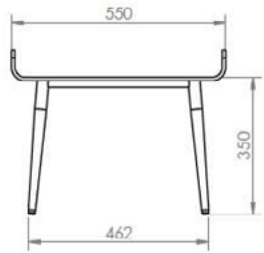

PI M.1

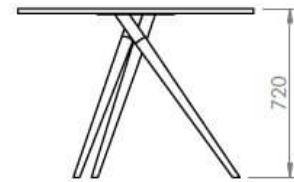
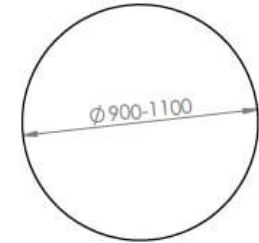
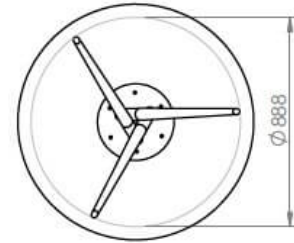

PI M.2

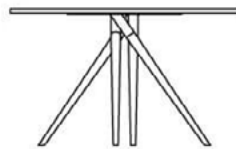
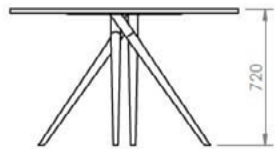
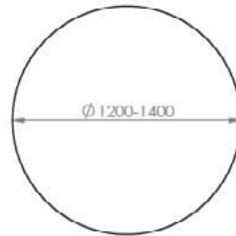
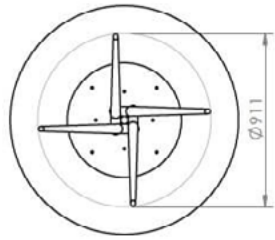

PI M.3

